



PRAESTEGAARD MODULAR SYSTEM

katalog1 DK | væg system 2014.01

INDHOLD

- 01 salgs- og leveringsbetingelser
- 03 væg units, B1040
- 04 væg units dobbeltsidet, smal B1040 el. B520
- 05 væg units, B520
- 07 væg units, S model, B1040
- 09 væg units, S model, B520
- 11 extension units
- 13 fittings for installation
- 16 lys bokse
- 17 væg plader for væg unit, B1040
- 19 væg plader for væg unit, B520
- 21 væg plader for væg unit, B1550
- 23 logo plader - top plader
- 24 toppe for dobbelt-sidet, smal væg set-up
- 25 hjørner - gavl plader
- 29 indramning - søjler og bokse
- 30 fitting for fritstående gondola set-up
- 31 gulv stander - podier for gondola set-up
- 34 gulv stander - podier for gondola set-up
- dobbeltsidet, smal væg units
- 36 gavl plader for podier - gondola set-up
- 37 podier, fritstående
- 40 glas units - base units
- 43 diske, top diske - base units
- 45 diske, glas til top diske



LEVERINGSBETINGELSER

De fleste modeller er normalt på lager til omgående levering.
Hvis ikke lager, vil leveringstid normalt være ca. 10 uger.

OBS. Der må påberegnes 8 dages ekspeditionstid fra ordreindgang.

Normalt sendes med fragtmand, ab fabrik for købers regning og risiko.
Køber er velkommen til at sørge for egen afhentning og forsikring.
Såfremt køber forlanger varer tilsendt en anden adresse end sin egen,
bortfalder reklamationsretten naturligvis, idet ingen af parterne ved
hvordan varen er modtaget og udpakket.

Der påberegnes et ekspeditionsgebyr ved køb under DKK. 2.500,00
på DKK. 95,00.

BETALINGSBETINGELSER

Hvis ikke andet er aftalt, er betaling netto kontant ved afhentning
eller modtagelse.

Dette katalog er gældende indtil ny katalog udkommer.

FABRIKSGARANTI

Såfremt der kan påvises en fabrikationsfejl, erstattes med en ny fra
fabrikken. *Returneres omgående (maks.2 dage efter modtagelse).*

Vi forbeholder os retten til ændring af konstruktion (forbedring)
og pris uden varsel.

RETURVARER

Returvarer modtages *ikke* uden en forudgående skriftlig aftale herfra
og *kun* i original indpakning samt i ubrugt stand.
Returneres senest 7 dage efter modtagelse for egen regning.

Vi tager forbehold for trykfejl.

VÆG UNIT / bredde 1040mm

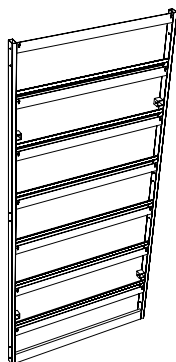

type nr / beskrivelse	materiale	dimensioner / vægt
1001/235 væg unit, 7 væg plader, H310mm	aluminium, pulverlakeret	H 2350mm B 1040mm D 50mm
inkluderet - 2x stillesko M10 - 3x bolt M6x70 - 3x møtrik M6	farve mørk grå metallic	14,30kg

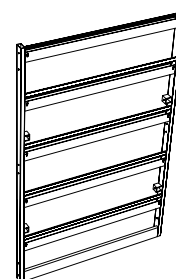

type nr / beskrivelse	materiale	dimensioner / vægt
1002/170 væg unit, 5 væg plader, H310mm	aluminium, pulverlakeret	H 1700mm B 1040mm D 50mm
inkluderet - 2x stillesko M10 - 3x bolt M6x70 - 3x møtrik M6	farve mørk grå metallic	10,60kg

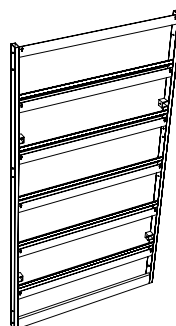

type nr / beskrivelse	materiale	dimensioner / vægt
1001/201 væg unit, 6 væg plader, H310mm	aluminium, pulverlakeret	H 2010mm B 1040mm D 50mm
inkluderet - 2x stillesko M10 - 3x bolt M6x70 - 3x møtrik M6	farve mørk grå metallic	13,00kg



VÆG UNIT / bredde 1040mm

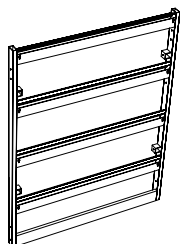

type nr / beskrivelse	materiale	dimensioner / vægt
1002/136 væg unit, 4 væg plader, H310mm	aluminium, pulverlakeret	H 1360mm B 1040mm D 50mm
inkluderet - 2x stillesko M10 - 2x bolt M6x70 - 2x møtrik M6	farve mørk grå metallic	8,00kg

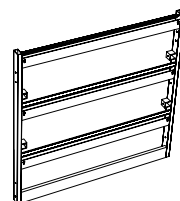

type nr / beskrivelse	materiale	dimensioner / vægt
1002/102 væg unit, 3 væg plader, H310mm	aluminium, pulverlakeret	H 1020mm B 1040mm D 50mm
inkluderet - 2x stillesko M10 - 2x bolt M6x70 - 2x møtrik M6	farve mørk grå metallic	6,50kg



VÆG UNIT DOBBELT-SIDET, SMAL / bredde 1040mm og 520mm

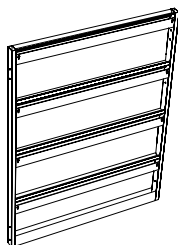

<u>type nr / beskrivelse</u>	<u>materiale</u>	<u>dimensioner / vægt</u>
1002/136/GS væg unit, dobbelt-sidet, smal. 8 væg plader, H310mm	aluminium, pulverlakeret	H 1360mm B 1040mm D 50mm
inkluderet - 2x stillesko M10 - 2x bolt M6x70 - 2x møtrik M6	farve mørk grå metallic	13,50kg

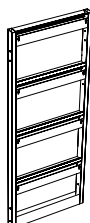

<u>type nr / beskrivelse</u>	<u>materiale</u>	<u>dimensioner / vægt</u>
1002-52/136/GS væg unit, dobbelt-sidet, smal. 8 væg plader, H310mm	aluminium, pulver lakeret	H 1360mm B 520mm D 50mm
inkluderet - 2x stillesko M10 - 2x bolt M6x70 - 2x møtrik M6	farve mørk grå metallic	6,70kg



VÆG UNIT / bredde 520mm

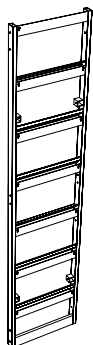

type nr / beskrivelse	materiale	dimensioner / vægt
1001-52/235 væg unit, 7 væg plader, H310mm	aluminium, pulverlakeret	H 2350mm B 520mm D 50mm
inkluderet - 2x stillesko M10 - 3x bolt M6x70 - 3x møtrik M6	farve mørk grå metallic	8,90kg

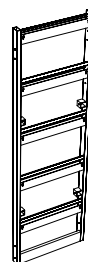

type nr / beskrivelse	materiale	dimensioner / vægt
1001-52/170 væg unit, 5 væg plader, H310mm	aluminium, pulverlakeret	H 1700mm B 520mm D 50mm
inkluderet - 2x stillesko M10 - 3x bolt M6x70 - 3x møtrik M6	farve mørk grå metallic	6,40kg

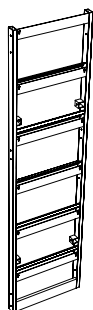

type nr / beskrivelse	materiale	dimensioner / vægt
1001-52/201 væg unit, 6 væg plader, H310mm	aluminium, pulverlakeret	H 2010mm B 520mm D 50mm
inkluderet - 2x stillesko M10 - 3x bolt M6x70 - 3x møtrik M6	farve mørk grå metallic	7,50kg

VÆG UNIT / bredde 520mm

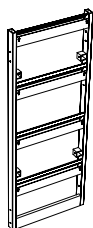

type nr / beskrivelse	materiale	dimensioner / vægt
1002-52/136 væg unit, 4 væg plader, H310mm	aluminium, pulverlakeret	H 1360mm B 520mm D 50mm
inkluderet - 2x stillesko M10 - 2x bolt M6x70 - 2x møtrik M6	farve mørk grå metallic	4,50kg

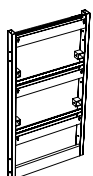

type nr / beskrivelse	materiale	dimensioner / vægt
1002-52/102 væg unit, 3 væg plader, H310mm	aluminium, pulverlakeret	H 1020mm B 520mm D 50mm
inkluderet - 2x stillesko M10 - 2x bolt M6x70 - 2x møtrik M6	farve mørk grå metallic	3,70kg



VÆG UNIT S-MODEL / bredde 1040mm

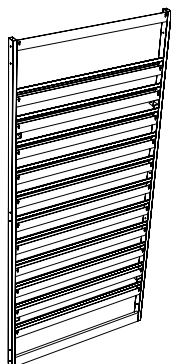

type nr / beskrivelse	materiale	dimensioner / vægt
1001/S/235 væg unit, 2 væg plader, H310mm 10 væg plader, H140mm	aluminium, pulverlakeret	H 2350mm B 1040mm D 50mm
inkluderet - 2x stillesko M10 - 3x bolt M6x70 - 3x møtrik M6	farve mørk grå metallic	23,00kg

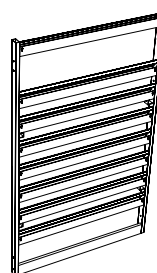

type nr / beskrivelse	materiale	dimensioner / vægt
1002/S/170 væg unit, 2 væg plader, H310mm 6 væg plader, H140mm	aluminium, pulverlakeret	H 1700mm B 1040mm D 50mm
inkluderet - 2x stillesko M10 - 3x bolt M6x70 - 3x møtrik M6	farve mørk grå metallic	14,90kg

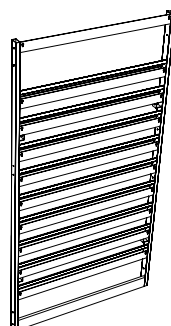

type nr / beskrivelse	materiale	dimensioner / vægt
1001/S/201 væg unit, 2 væg plader, H310mm 8 væg plader, H140mm	aluminium, pulverlakeret	H 2010mm B 1040mm D 50mm
inkluderet - 2x stillesko M10 - 3x bolt M6x70 - 3x møtrik M6	farve mørk grå metallic	21,00kg

VÆG UNIT S-MODEL / bredde 1040mm

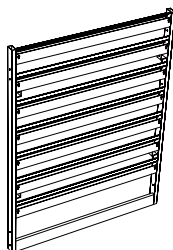

type nr / beskrivelse	materiale	dimensioner / vægt
1002/S/136 væg unit, 1 væg plade, H310mm 6 væg plader, H140mm	aluminium, pulverlakeret	H 1360mm B 1040mm D 50mm
inkluderet - 2x stillesko M10 - 2x bolt M6x70 - 2x møtrik M6	farve mørk grå metallic	13,80kg

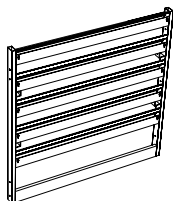

type nr / beskrivelse	materiale	dimensioner / vægt
1002/S/102 væg unit, 1 væg plade, H310mm 4 væg plader, H140mm	aluminium, pulverlakeret	H 1020mm B 1040mm D 50mm
inkluderet - 2x stillesko M10 - 2x bolt M6x70 - 2x møtrik M6	farve mørk grå metallic	11,00kg

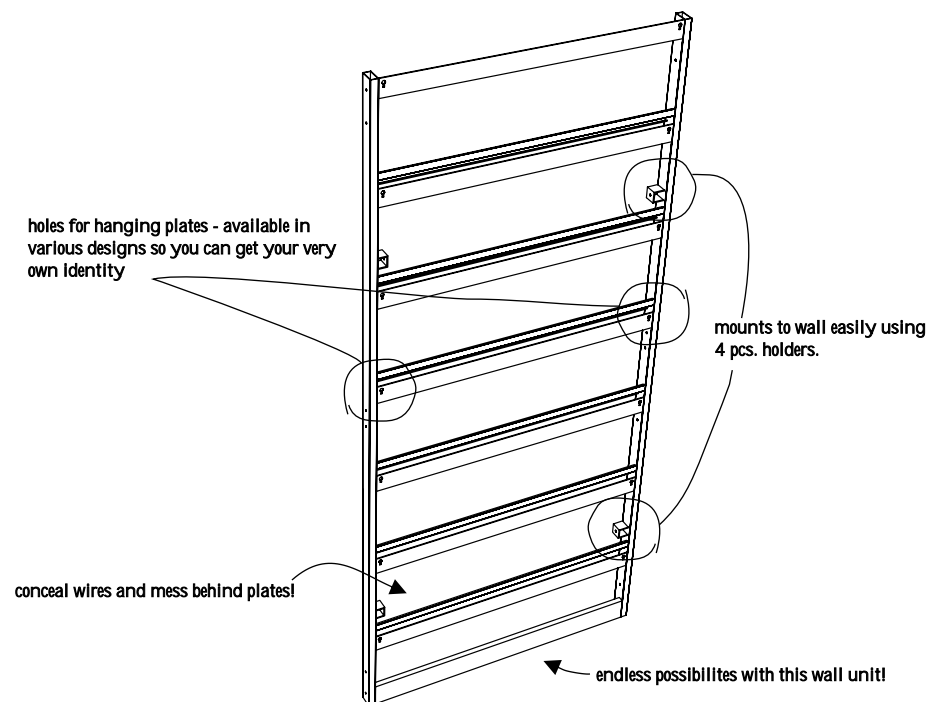

VÆG UNIT S-MODEL / bredde 520mm

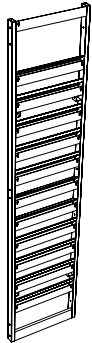

type nr / beskrivelse	materiale	dimensioner / vægt
1001-52/S/235 væg unit, 2 væg plader, H310mm 10 væg plader, H140mm	aluminium, pulverlakeret	H 2350mm B 520mm D 50mm
inkluderet - 2x stillesko M10 - 3x bolt M6x70 - 3x møtrik M6	farve mørk grå metallic	14,90kg

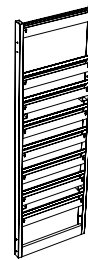

type nr / beskrivelse	materiale	dimensioner / vægt
1001-52/S/170 væg unit, 2 væg plader, H310mm 6 væg plader, H140mm	aluminium, pulverlakeret	H 1700mm B 520mm D 50mm
inkluderet - 2x stillesko M10 - 3x bolt M6x70 - 3x møtrik M6	farve mørk grå metallic	8,40kg

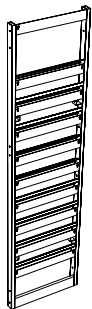

type nr / beskrivelse	materiale	dimensioner / vægt
1001-52/S/201 væg unit, 2 væg plader, H310mm 8 væg plader, H140mm	aluminium, pulverlakeret	H 2010mm B 520mm D 50mm
inkluderet - 2x stillesko M10 - 3x bolt M6x70 - 3x møtrik M6	farve mørk grå metallic	13,40kg



VÆG UNIT S-MODEL / bredde 520mm

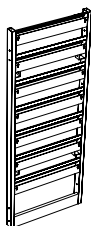

type nr / beskrivelse	materiale	dimensioner / vægt
1002-52/S/136 væg unit, 1 væg plader, H310mm 6 væg plader, H140mm	aluminium, pulverlakeret	H 1360mm B 520mm D 50mm
inkluderet - 2x stillesko M10 - 2x bolt M6x70 - 2x møtrik M6	farve mørk grå metallic	6,90kg

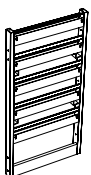

type nr / beskrivelse	materiale	dimensioner / vægt
1002-52/S/102 væg unit, 1 væg plader, H310mm 4 væg plader, H140mm	aluminium, pulverlakeret	H 1020mm B 520mm D 50mm
inkluderet - 2x stillesko M10 - 2x bolt M6x70 - 2x møtrik M6	farve mørk grå metallic	5,60kg

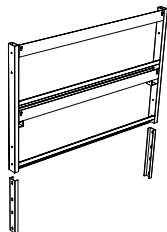

type nr / beskrivelse	materiale	dimensioner / vægt
1001/EX/68 forlænger unit, 2 væg plader, H310mm	aluminium, pulverlakeret	H 680mm B 1040mm D 50mm
inkluderet - 2x samlebeslag - 2x bolt M6x70 - 2x møtrik M6	farve mørk grå metallic	4,00kg

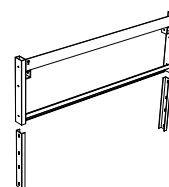

type nr / beskrivelse	materiale	dimensioner / vægt
1001/EX/34-2 forlænger unit, 1 væg plade, H310mm	aluminium, pulverlakeret	H 340mm B 1040mm D 50mm
inkluderet - 2x samlebeslag - 2x bolt M6x70 - 2x møtrik M6	farve mørk grå metallic	3,40kg

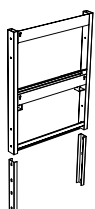

type nr / beskrivelse	materiale	dimensioner / vægt
1001-52/EX/68 forlænger unit, 2 væg plader, H310mm	aluminium, pulverlakeret	H 680mm B 520mm D 50mm
inkluderet - 2x samlebeslag - 2x bolt M6x70 - 2x møtrik M6	farve mørk grå metallic	2,60kg

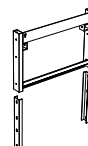

type nr / beskrivelse	materiale	dimensioner / vægt
1001-52/EX/34 forlænger unit, 1 væg plade, H310mm	aluminium, pulverlakeret	H 340mm B 520mm D 50mm
inkluderet - 2x samlebeslag - 2x bolt M6x70 - 2x møtrik M6	farve mørk grå metallic	2,00kg

FORLÆNGER FITTING /

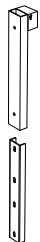

type nr / beskrivelse	materiale	dimensioner / vægt
1001/EX/34-N forlænger fitting, 1 væg plade, H650mm eller H665mm	aluminium, pulverlakeret	H 340mm B 50mm D 25mm
inkluderet - 1x samlebeslag - 2x bolt M6x70 - 2x møtrik M6	farve mørk grå metallic	0,26kg



type nr / beskrivelse	materiale	dimensioner / vægt
1001/EX/17 forlænger fitting, 1 væg plade, H480mm	aluminium, pulverlakeret	H 170mm B 50mm D 25mm
inkluderet - 1x samlebeslag - 1x bolt M6x70 - 1x møtrik M6	farve mørk grå metallic	0,15kg



INSTALLATION / tilbehør for montering

type nr / beskrivelse	materiale	dimensioner / vægt
1000 grundbeslag med flange til montage af væg unit på væg	aluminium farve aluminium	H 100mm B 65mm D 78mm 0,10kg

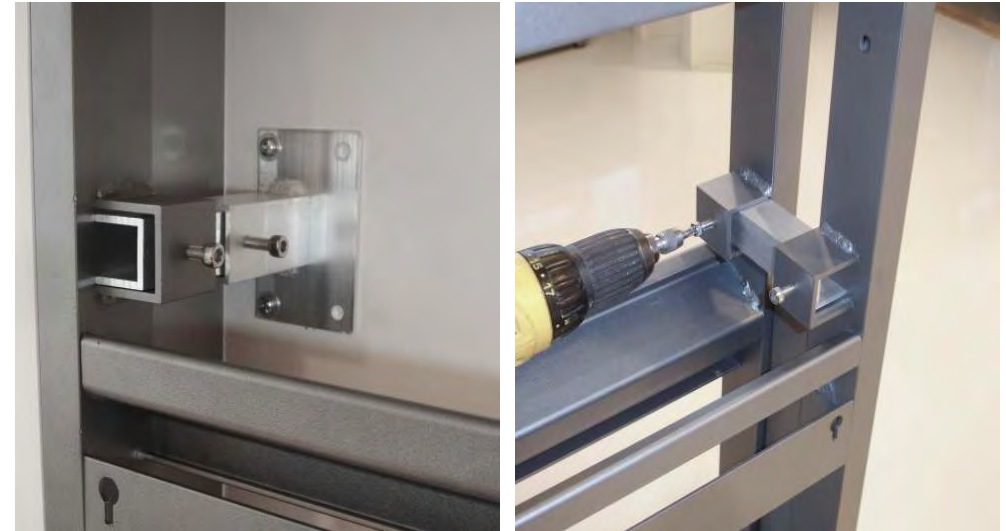
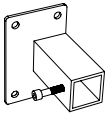

type nr / beskrivelse	materiale	dimensioner / vægt
1001/A afstandsør til grundbeslag for montage af væg units samt samling af væg units dobbeltsidet inkluderet 2x bolt M6x20 type nr 1000/11 1000/30 1000/63,5 1000/115,5	aluminium farve aluminium	D 110mm / 0,07kg D 300mm / 0,19kg D 635mm / 0,40kg D1155mm / 0,76kg

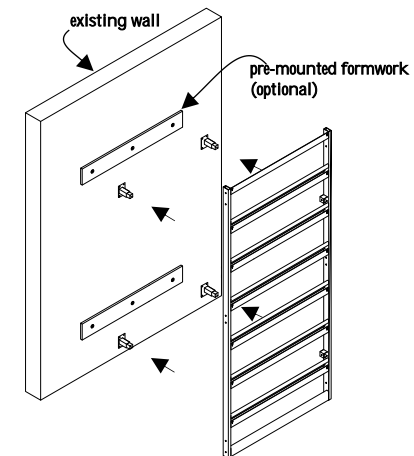
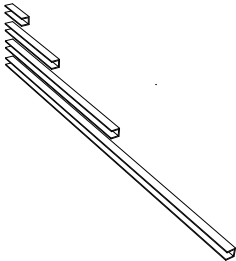

type nr / beskrivelse materiale dimensioner / vægt

1002/A
toppladebeslag til montage
af topplade 1102/A ved
dobbeltsidet montering.

aluminium,
pulverlakeret

H 15mm
B 1025mm
D 70mm

farve
mørk grå metallic

1,30kg

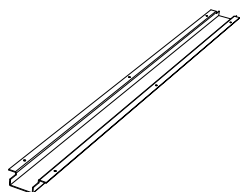

type nr / beskrivelse materiale dimensioner / vægt

1002/B
toppladebeslag til montage
af topplade 1102/B ved
dobbeltsidet montering.

aluminium,
pulverlakeret

H 15mm
B 505mm
D 70mm

farve
mørk grå metallic

0,70kg

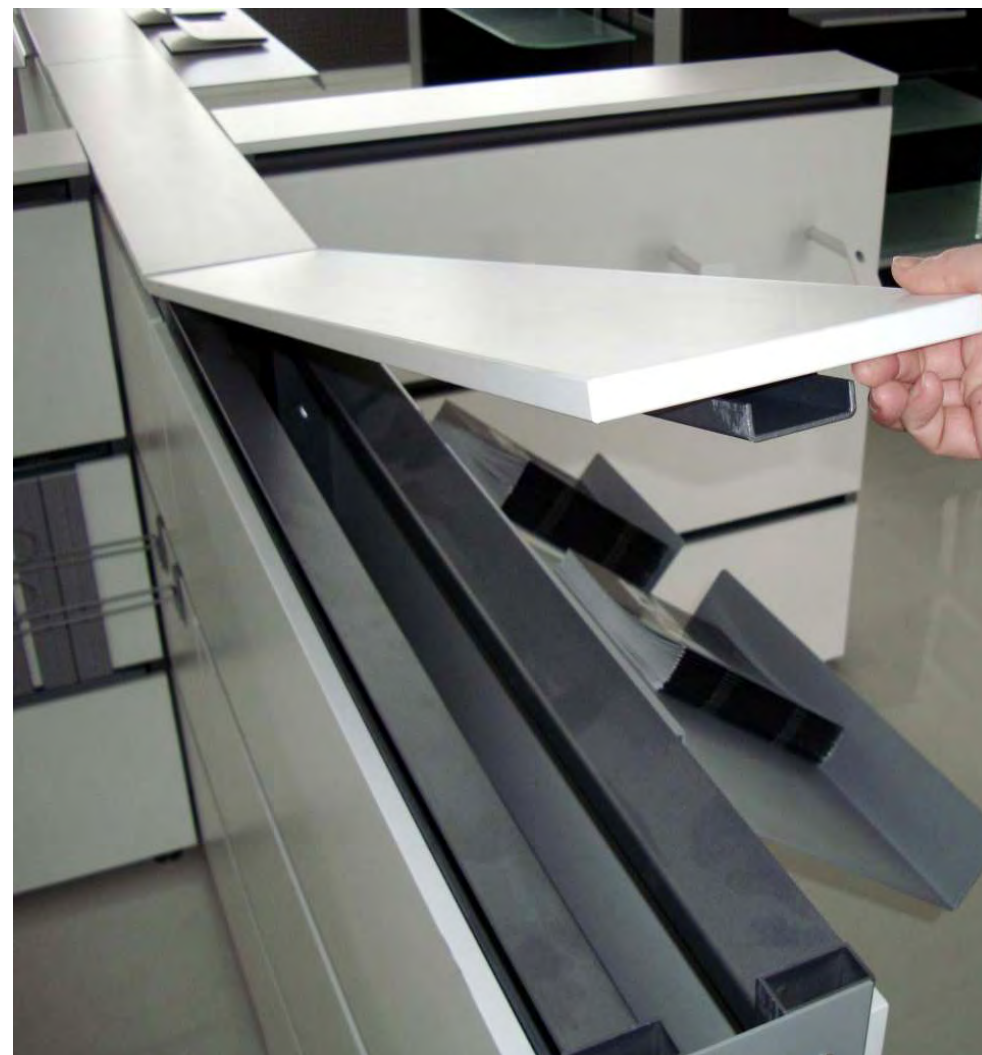
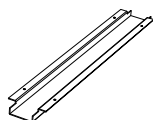

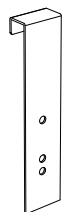

type nr / beskrivelse	materiale	dimensioner / vægt
1000/T/GS t-samle beslag for opstilling af fritstående dobbeltsidet, smal væg units type 1002/136/GS eller 1002-52/136/GS i T- eller H-opstilling	jern, pulver lakeret farve lys grå metallic	H 215mm B 46mm 0,30kg

inkluderet
- 2x bolt M6x40
- 2x møtrik M6

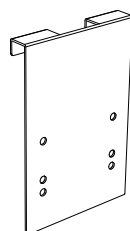

type nr / beskrivelse	materiale	dimensioner / vægt
1000/T t-samle beslag for opstilling af fritstående væg units i T- eller H-opstilling	jern, pulverlakeret farve lys grå metallic	H 215mm B 146mm 0,60kg

inkluderet
- 2x bolt M6x12
- 4x bolt M6x40
- 4x møtrik M6



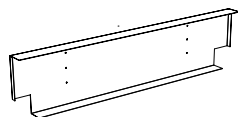

type nr / beskrivelse	materiale	dimensioner / vægt
1001/LB lysboks for væg- og forlænger units med bredde 104cm	jern, pulverlakeret	H 225mm B 986mm D 51mm
inkluderet 2x selvskærende skrue D4,5xL16mm	farve hvid	3,10kg
1001/LB-A lysarmatur for lysboks 1001/LB inkl. lysrør 21W/220V samt ledning m/stik		B 870mm

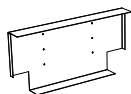

type nr / beskrivelse	materiale	dimensioner / vægt
1001-52/LB lysboks for væg- og forlænger units med bredde 52cm	jern, pulverlakeret	H 225mm B 466mm D 51mm
inkluderet 2x selvskærende skrue D4,5xL16mm	farve hvid	1,50kg
1001/LB-A lysarmatur for lysboks 1001-52/LB inkl. lysrør 8W/220V samt ledning m/stik		B 310mm

PLADER / for væg units B1040mm

type nr / beskrivelse materiale dimensioner / vægt

1101/14
plade for væg units - S model
H 140mm
B 1030mm
D 15mm
inkluderet
2x træskruer
mdf / melamin, hvid | e 01
mdf / vådlakering | e 01 eller e 02 1,60kg



type nr / beskrivelse materiale dimensioner / vægt

1101/32,5
plade for væg units
H 325mm
B 1030mm
D 15mm
inkluderet
2x træskruer
mdf / vådlakering | e 01
3,90kg



type nr / beskrivelse materiale dimensioner / vægt

1101/31
plade for væg units
H 310mm
B 1030mm
D 15mm
inkluderet
2x træskruer
mdf / melamin, hvid | e 01
mdf / vådlakering | e 01 3,70kg



type nr / beskrivelse materiale dimensioner / vægt

1101/48
plade for væg units - S model
H 480mm
B 1030mm
D 15mm
inkluderet
2x træskruer
mdf / melamin, hvid | e 01
mdf / vådlakering | e 01 eller e 02 6,10kgs



PLADER / for væg units B1040mm

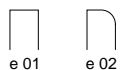

type nr / beskrivelse	materiale	dimensioner / vægt
1101/65 plade for væg units		H 650mm B 1030mm D 15mm
inkluderet 4x træskruer	mdf / melamin, hvid e 01 mdf / vådlakering e 01	7,60kg

Du kan vælge mellem mange forskellige designs og størrelser væg plader og dermed designe dit helt eget look og brand.

Standard bredden er 1040, 520 og 1550 mm og højder er 140, 310, 325, 480, 650 og 665mm.

Materialet er altid mdf, og du kan vælge mellem melamin eller våd lakering. Vi vil som regel have nogle standard designs på lager, men alt efter ordre størrelse kan vi tilbyde custommade væg plader.

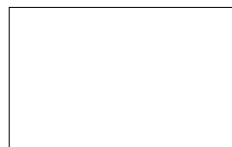

type nr / beskrivelse	materiale	dimensioner / vægt
1101/66,5 plade for væg units		H 665mm B 1030mm D 15mm
inkluderet 4x træskruer	mdf / vådlakering e 01	7,90kg



PLADER / for væg units B520mm

type nr / beskrivelse materiale dimensioner / vægt

1101-51/14
plade for væg units - S model
H 140mm
B 510mm
D 15mm
inkluderet
2x træskruer
mdf / melamin, hvid | e 01
mdf / vådlakering | e 01 eller e 02 0,88kg



type nr / beskrivelse materiale dimensioner / vægt

1101-51/32,5
plade for væg units
H 325mm
B 510mm
D 15mm
inkluderet
2x træskruer
mdf / vådlakering | e 01
2,10kg

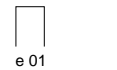

type nr / beskrivelse materiale dimensioner / vægt

1101-51/31
plade for væg units
H 310mm
B 510mm
D 15mm
inkluderet
2x træskruer
mdf / melamin, hvid | e 01
mdf / vådlakering | e 01 eller e 02 1,90kg

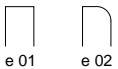
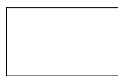

type nr / beskrivelse materiale dimensioner / vægt

1101-51/48
plade for væg units - S model
H 480mm
B 510mm
D 15mm
inkluderet
2x træskruer
mdf / melamin, hvid | e 01
mdf / vådlakering | e 01 eller e 02 2,78kg



PLADER / for væg units B520mm

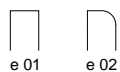
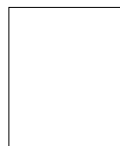

type nr / beskrivelse	materiale	dimensioner / vægt
1101-51/65 plade for væg units		H 650mm B 510mm D 15mm
inkluderet 4x træskruer	mdf / melamin, hvid e 01 mdf / vådlakering e 01 eller e 02	4,30kg



type nr / beskrivelse	materiale	dimensioner / vægt
1101-51/66,5 plade for væg units		H 665mm B 510mm D 15mm
inkluderet 4x træskruer	mdf / vådlakering e 01	4,90kg



PLADER / for væg units B1550mm

type nr / beskrivelse materiale dimensioner / vægt

1101-155/31
plade for 3x væg units med
bredde 52cm eller 1x væg
unit B104cm og 1x væg
unit B52cm

H 310mm
B 1550mm
D 15mm

5,60kg

inkluderet
6x træskruer

mdf / vådlakering | e 02



type nr / beskrivelse materiale dimensioner / vægt

1101-155/65
plade for 3x væg units med
bredde 52cm eller 1x væg
unit B104cm og 1x væg
unit B52cm

H 650mm
B 1550mm
D 15mm

11,90kg

inkluderet
12x træskruer

mdf / vådlakering | e 02



PLADER / top plader -toppe

Vi har et stort udvalg af forskellige top plader og toppe, så du kan skabe dit eget look. Top plader anvendes sammen med beslag til fastgørelse - type nr 1002/A og 1002/B. Toppe bruges på de dobbeltsidet, smalle væg units type nr 1002/136/GS og 1002-52/136/GS.

Standard bredden er 1040mm eller 520mm og højder for top pladen 15mm og for top 30mm.

Materialet er altid mdf og du kan vælge mellem melamin eller våd lakeret - vi vil have nogle standard designs på lager, men alt efter ordrestørrelse kan vi tilbyde specialfremstillede top plader og toppe.



PLADER / logo plader - top plader

LOGO

type nr / beskrivelse	materiale
1001/LOGO 1001-51/LOGO 1001-155/LOGO udstansning af logo i plade til væg units inkl. opal akryl plade. bruges sammen med lysboks type 1001/LB eller 1001-52/LB.	kun mdf / vådlakeret plader

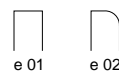

type nr / beskrivelse	materiale	dimensioner / vægt
1102/A top plade monteres med type nr 1002/A for dobbelsidet vægopstilling		H 15mm B 1040mm D 182mm
inkluderet 6x træskruer	mdf / melamin, hvid e 01 mdf / vådlakering e 01 eller e 02	1,10kg



type nr / beskrivelse	materiale	dimensioner / vægt
1102/B top plade monteres med type nr 1002/B for dobbelsidet vægopstilling		H 15mm B 520mm D 182mm
inkluderet 4x træskruer	mdf / melamin, hvid e 01 mdf / vådlakering e 01 eller e 02	0,88kg

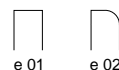

PLADER / toppe for lav dobbelt-sidet, smal væg unit

<u>type nr / beskrivelse</u>	<u>materiale</u>	<u>dimensioner / vægt</u>
------------------------------	------------------	---------------------------

1102/A/GLS

top for dobbeltsidet, smal
væg unit B1040mm

H 30mm
B 1040mm
D 80mm

inkluderet

2x fitting

mdf / vådlakering

1,50kg



<u>type nr / beskrivelse</u>	<u>materiale</u>	<u>dimensioner / vægt</u>
------------------------------	------------------	---------------------------

1102/B/GLS

top for dobbeltsidet, smal
væg unit B520mm

H 30mm
B 520mm
D 80mm

inkluderet

2x fitting

mdf / vådlakering

1,00kg



Vi har en hel række forskellige hjørne units, hjørne profiler og endeplader.

Metal, pulverlakeret:

type numre 1020-1090 - hjørne units i 8 højder for samling af væg units dobbeltsidet i en vinkel af 90 grader.

type numre 1021-1090 - hjørne profil i 6 højder for samling af væg units i en vinkel af 90 grader. Vi kan også tilbyde speciel hjørne profil på 45 grader med højden 235cm eller 22,5 grader med højde 235cm og 201cm. Brug 22,5 graders profil hvis du ønsker buede vægge.

Du kan også bruge type nr 1021-SQ/235 så hjørnerne får et mere "blødt" look

type numre 1022 - endeplader i 6 højder til montering på væg units for enkelt installation eller vi har endeplader i 2 højder til montering på væg units til dobbeltsidet installation.

Træ, vådlakeret:

type numre 1103/R - i 7 højder, anvendes som endeplade og er baseret på opskæring i forskellige dybder.

type numre 1103/DR - i 7 højder, anvendes som endeplade på dobbeltsidet monterede væg units.

type nr 1103/DRW/137, 5 - 1 højde bruges til endeplade på dobbeltsidet monterede væg units.
type numre 1103/GS/137, 5 og 1103/GS/147, 5 bruges til endeplade på dobbeltsidet, smal væg units med type numre 1002/136/GS og 1002-52/136/GS med top H30mm eller top H130mm.

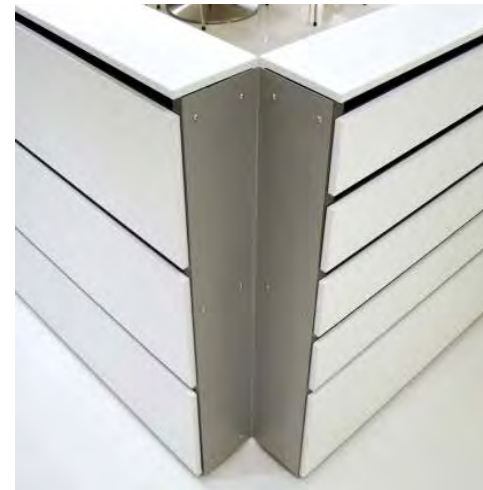

type nr 1020-90



type nr 1021-90



type nr 1022



type nr 1103/R



type nr 1021-22,5

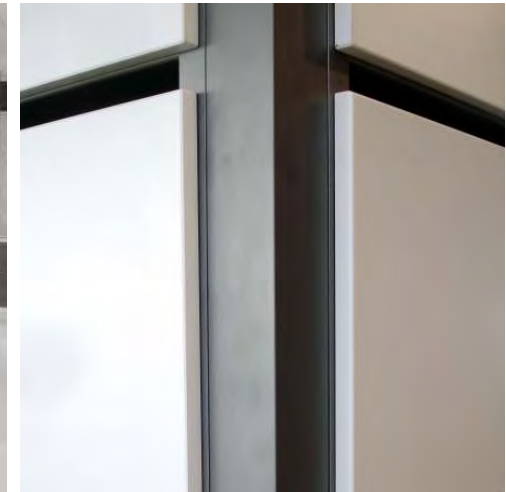

type nr 1021-SQ/235

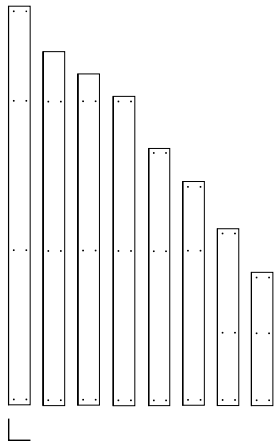

type nr / beskrivelse	materiale	dimensioner / vægt
1020-90 hjørne units i 8 højder for samling af dobbeltsidet væg units i en vinkel af 90 grader	aluminium, pulverlakeret	B 166mm D 166mm
inkluderet - 16x bolt/R M6x40 /16x møtrik M6 f/type 1020-90/303. - 12x bolt/R M6x40 /12x møtrik M6 for øvrige typer.	farve lys grå metallic	
type nr 1020-90/303 1020-90/269 1020-90/252 1020-90/235 1020-90/201 1020-90/170 1020-90/136 1020-90/102		H 3030mm / 5,05kg H 2690mm / 4,50kg H 2520mm / 2,20kg H 2350mm / 3,90kg H 2010mm / 3,40kg H 1700mm / 2,90kg H 1360mm / 2,20kg H 1020mm / 1,70kg



1021-SQ/235 hjørne profil, kvadratisk i højde 235cm for samling af væg units i en vinkel af 90 grader	aluminium, pulverlakeret	H 2350mm B 60mm D 60mm
inkluderet 6x selvskærende skruer	farve lys grå metallic	1,40kg

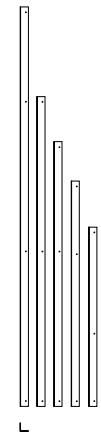

type nr / beskrivelse	materiale	dimensioner / vægt
1021-90 hjørne profil i 6 højder for samling af væg units i en vinkel af 90 grader Fås også i en vinkel af 45 grader i højden 235cm samt i en vinkel af 22,5 grader i højderne 235cm og 201cm.	aluminium, pulverlakeret	B 66mm D 66mm
inkluderet - 8x bolt/R M6x40 /8x møtrik M6 for type 1021-90/303. - 6x bolt/R M6x40 6x møtrik M6 for øvrige typer. - 6x selvskærende skruer for type 1021-22,5/235 og 1021-22,5/201	farve lys grå metallic	
type nr 1021-90/303 1021-90/235 1021-90/201 1021-90/170 1021-90/136 1021-90/102 1021-45/235 1021-22,5/235 1021-22,5/201		H 3030mm / 1,90kg H 2350mm / 1,40kg H 2010mm / 1,20kg H 1700mm / 1,10kg H 1360mm / 0,90kg H 1020mm / 0,60kg H 2350mm / 1,40kg H 2350mm / 1,40kg H 2010mm / 1,20kg

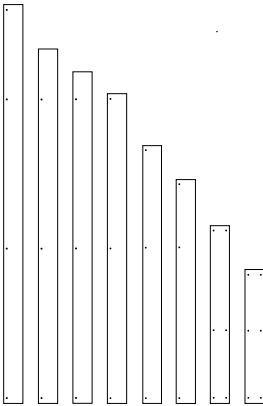
type nr / beskrivelse	materiale	dimensioner / vægt
 <p>1022 gavlplader i 6 højder for montering på væg units, enkeltstående. gavlplader i 2 højder for montering på væg units for dobbeltsidet installation. dybden er tilpaset m. afstandsør type 1000/A lgd. 11cm</p> <p>inkluderet - 4x bolt/R M6x40 / 4x møtrik M6 for 1022/303 - 3x bolt/R M6x40 / 3x møtrik M6 for 1022/269, 1022/252, 1022/235, 1022/201 og 1022/170 - 6x bolt/R M6x40 / 6x møtrik M6 for 1022/136 og 1022/102</p> <p>type nr 1022/303 1022/269 1022/252 1022/235 1022/201 1022/170 1022/136 1022/102</p>	<p>aluminium, pulverlakeret</p> <p>farve lys grå metallic</p>	B 150mm

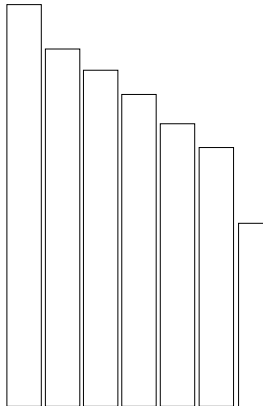
type nr / beskrivelse	materiale	dimensioner / vægt
 <p>1103/R plader i 7 højder til brug for gavplade, kan tilskæres til forskellige dybder</p> <p>type nr 1103/R-303 1103/R-269 1103/R-252 1103/R-235 1103/R-218 1103/R-201 1103/R-171,5</p>	<p>mdf / vådlakering e 01 eller e 02</p>	B 350mm D 15mm

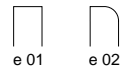

INSTALLATION / gavlplader

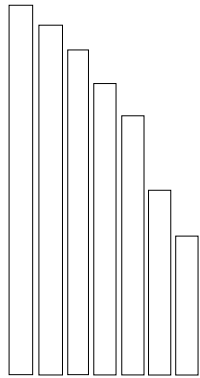

type nr / beskrivelse	materiale	dimensioner / vægt
1103/DR plade i 7 højder til brug for gavlplader. Kan bruges til dobbeltsidet opstilling dybden er tilpaset m. afstandsrør type 1000/A lgd. 11cm	mdf / vådlakering e 01 eller e 02	B 150mm
type nr 1103/DR-269		H 2690mm / 5,40kg
1103/DR-252		H 2520mm / 4,80kg
1103/DR-235		H 2350mm / 4,20kg
1103/DR-201		H 2010mm / 3,20kg
1103/DR-171,5		H 1715mm / 2,80kg
1103/DR-137,5		H 1375mm / 2,20kg
1103/DR-103,5		H 1035mm / 1,80kg



type nr / beskrivelse	materiale	dimensioner / vægt
1103/DRW/137,5 plade til brug for gavlplade ved dobbeltsidet opstilling af væg units dybden er tilpaset m. afstandsrør type 1000/A lgd. 11cm	mdf / melamin, hvid e 01 mdf / vådlakering e 01	H 1375mm B 182mm D 15mm 2,50kg

type nr / beskrivelse	materiale	dimensioner / vægt
1103/GS/137,5 plader i 1 højde til brug som gavlplade til dobbeltsidet, smalle væg units højden er justeret efter top H30mm	mdf / vådlakering e 01	B 80mm D 15mm H 1375mm 1,20kg



INDRAMNING / søjler - top bokse

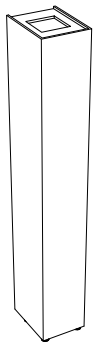

type nr / beskrivelse	materiale	dimensioner / vægt
1104/C-235 søjle for montering til væg unit H2350mm	mdf / vådlakering	H 2350mm B 310mm D 396mm
inkluderet 4x stillesko 6x træskruer 5x35mm	farve hvid	



type nr / beskrivelse	materiale	dimensioner / vægt
1104/T-31 top boks for væg unit med bredde 1040mm monteret enten alene eller sammen med søjle 1104/C-235 el. 1104/C/EX-68	mdf / vådlakering	H 310mm B 1030mm D 250mm
inkluderet - 2x træskruer 3,5x16mm	farve hvid	

type nr / beskrivelse	materiale	dimensioner / vægt
1104/C/EX-68 forlænger søjle som bruges sammen med 1104/C-235	mdf / vådlakering	H 680mm B 310mm D 396mm
inkluderet 4x træskruer 5x35cm	farve hvid	

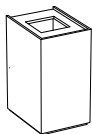

type nr / beskrivelse	materiale	dimensioner / vægt
1104-51/-31 top boks for væg unit med bredde 520mm monteret enten alene eller sammen med søjle 1104/C-235 el. 1104/C/EX-68	mdf / vådlakering	H 310mm B 510mm D 250mm
inkluderet - 2x træskruer 3,5x16mm	farve hvid	

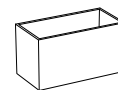

INSTALLATION / fitting for gondola, fritstående

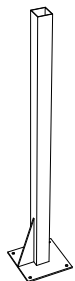

type nr / beskrivelse	materiale	dimensioner / vægt
1005 gulvstativ for montage af fritstående væg units. boltes i eks. gulv eller boltes i plade type 1005/P for flytbar udgave.	jern, pulverlakeret farve mørk grå metallic	H 1000mm B 175mm D 175mm 3,90kg



type nr / beskrivelse	materiale	dimensioner / vægt
1005/P plade for montage af gulvstativ type 1005	jern, pulverlakeret farve mørk grå metallic	B 400mm D 900mm 11,40kg

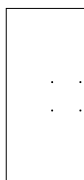

INSTALLATION / gulv stander for gondola med podie

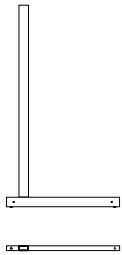

type nr / beskrivelse	materiale	dimensioner / vægt
1005/GL-59,5 gulvstativ, enkelt-sided for montage af flytbar fritstående væg units Kan monteres med 1 set ben 1005/GH-11,5, hvorved total højde bliver 116,5cm.	jern, pulverlakeret farve lys grå metallic	H 1050mm B 25mm D 580mm 4,50kg
inkluderet		
- 2x forhøjer H15mm til montering i lodret profil i væg unit		
- 2x samlebeslag		
- 2x stillesko M10		
- 1x gevindstang M10x70		

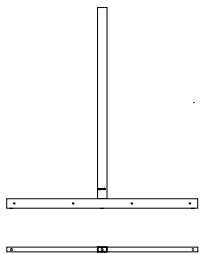

type nr / beskrivelse	materiale	dimensioner / vægt
1005/GL-101 gulvstativ, dobbeltsidet for montage af flytbar fritstående væg units Kan monteres med 1 set ben 1005/GH-11,5, hvorved total højde bliver 116,5cm.	jern, pulverlakeret farve lys grå metallic	H 1050mm B 25mm D 1010mm 5,60kg
inkluderet		
- 2x forhøjer H15mm til montering i lodret profil i væg unit		
- 2x samlebeslag		
- 2x stillesko M10		
- 1x gevindstang M10x70		

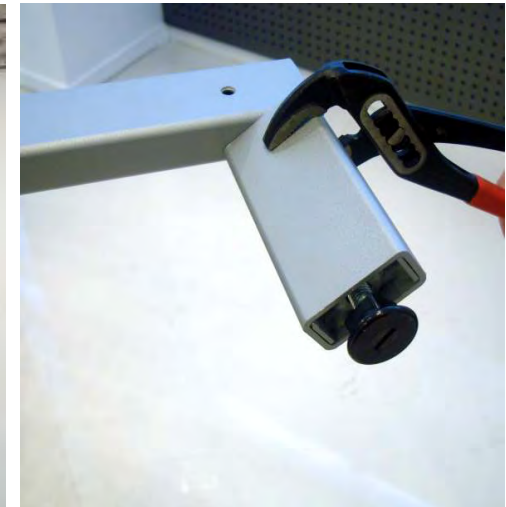

INSTALLATION / ben - podier, lavt for gondola fritstående

type nr / beskrivelse	materiale	dimensioner / vægt
1005/GH-11,5 sæt af ben - i alt 2 stk. til gulvstativ type nr. 1005/GL-59,5, 1005/GL-101, 1005/GS/O og 1005/GS	jern, pulverlakeret farve lys grå metallic	H 115mm B 25mm D 50mm 0,80kg
inkluderet 1x gevindstang M10x70		



type nr / beskrivelse	materiale	dimensioner / vægt
1105/GL-52 podie for fritstående set-up af væg units B52cm med type 1005/GL-59,5 og 1005/GL-101	mdf, vådlakeret farve hvid	H 65mm B 520mm D 445mm 3,60kg



type nr / beskrivelse	materiale	dimensioner / vægt
1105/GL-104 podie for fritstående set-up af væg units B104cm med type 1005/GL-59,5 og 1005/GL-101	mdf, vådlakering farve hvid	H 65mm B 1040mm D 445mm 7,50kg



INSTALLATION / podier, højt for gondola fritstående

type nr / beskrivelse	materiale	dimensioner / vægt
1105/GH-104 podie for fritstående set-up af væg units B104cm med type 1005/GL-59,5 og 1005/GL-101 monteret med ben 1005/GH-11,5	mdf, vådlakeret farve hvid	H 180mm B 1040mm D 445mm 8,90kg

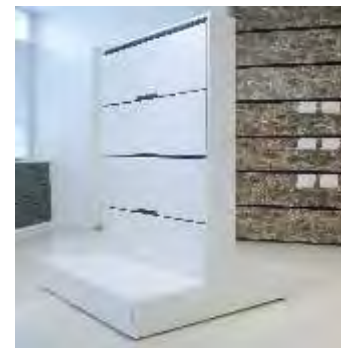

type nr / beskrivelse	materiale	dimensioner / vægt
1105/GH-52 podie for fritstående set-up af væg units B52cm med type 1005/GL-59,5 og 1005/GL-101 monteret med ben 1005/GH-11,5	mdf, vådlakeret farve hvid	H 180mm B 520mm D 445mm 4,30kg



INSTALLATION / gulv stander for gondola til dobbelt-sidet, smal væg unit

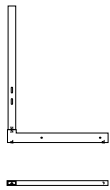

type nr / beskrivelse	materiale	dimensioner / vægt
1005/GS/O gulvstativ, enkeltsidet for montage af flytbar fritstående væg units type 1002/136/GS og 1002-52/136/GS. Kan monteres med 1 sæt ben 1005/GH-11,5, total højde bliver 83,1cm. inkluderet - 1x fitting for montering til væg unit - 2x stillesko M10 - 1x gevindstang M10x70	jern, pulverlakeret farve lys grå metallic	H 716mm B 25mm D 530mm 3,00kg



type nr / beskrivelse	materiale	dimensioner / vægt
1005/GS/EX extension for gulvstativ 1005/GS og 1005/GS/O. Kan også blive brugt sammen med 1005/GL-59,5 og 1005/GL-101. Kan monteres med 1 set ben 1005/GH-11,5. inkluderet - 2x stillesko M10 - 2x bolt M6x70 - 2x møtrik M6	jern, pulverlakeret farve lys grå metallic	H 50mm B 25mm D 480mm 1,50kg

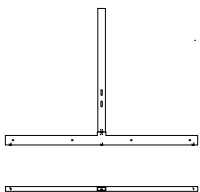

type nr / beskrivelse	materiale	dimensioner / vægt
1005/GS gulvstativ, dobbeltsidet for montage af flytbar fritstående væg units type 1002/136/GS og 1002-52/136/GS. Kan monteres med 1 set ben 1005/GH-11,5, hvorved total højde bliver 83,1cm. inkluderet - 1x fitting for montering til væg unit - 2x stillesko M10 - 1x gevindstang M10x70.	jern, pulverlakeret farve lys grå metallic	H 716mm B 25mm D 1010mm 4,50kg

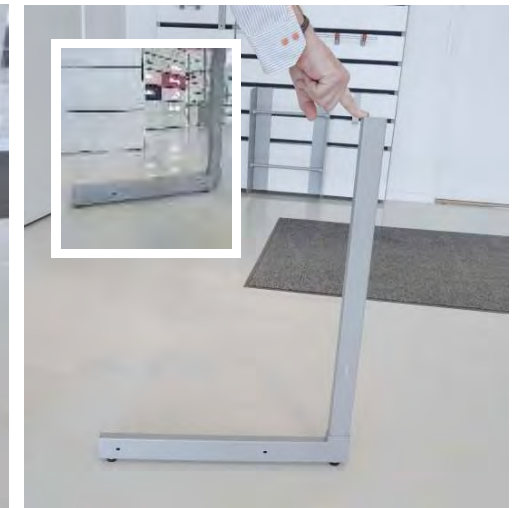

INSTALLATION / podie, lavt and højt - dobbelt-sidet, smal væg unit

type nr / beskrivelse	materiale	dimensioner / vægt
1105/GS/GL-104 podie for fritstående set-up af dobbeltsidet, smal væg units B104cm med type 1005/GS og 1005/GS/O	mdf, vådlakeret farve hvid	H 65mm B 1040mm D 495mm 7,70kg



item no. / description	material	dimensioner / vægt
1105/GS/GH-104 podie for fritstående set-up af dobbeltsidet, smal væg units B104cm med type 1005/GS og 1005/GS/O monteret med ben 1005/GH-11,5	mdf, vådlakeret farve hvid	H 180mm B 1040mm D 495mm 9,20kg



type nr / beskrivelse	materiale	dimensioner / vægt
1105/GS/GL-52 podie for fritstående set-up af dobbeltsidet, smal væg units B52cm med type 1005/GS og 1005/GS/O	mdf, vådlakeret farve hvid	H 65mm B 520mm D 495mm 3,80kg

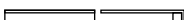

type nr / beskrivelse	materiale	dimensioner / vægt
1105/GS/GH-52 podie for fritstående set-up af dobbeltsidet, smal væg units B52cm med type 1005/GS og 1005/GS/O monteret med ben 1005/GH-11,5	mdf, vådlakeret farve hvid	H 180mm B 520mm D 495mm 4,00kg

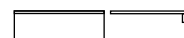

INSTALLATION / gavl plader for podier, for gondola

type nr / beskrivelse	materiale	dimensioner / vægt
-----------------------	-----------	--------------------

1105/GS/GL-DE

gavl plade for podie ved fritstående set-up af væg units og gulvstativer 1005/GL-101 og 1005/GS.

mdf, vådlakeret
farve
hvid

H 65mm
B 1040mm
D 15mm
0,80kg



Hvis du monterer ben 1005/GH-11,5 på gulvstativ så brug top plade 1102/A som gavl plade.

type nr / beskrivelse	materiale	dimensioner / vægt
-----------------------	-----------	--------------------

1105/GS/GL-SE

gavl plade for podie ved fritstående set-up af væg units og gulvstativ 1005/GS/O.

mdf, vådlakeret
farve
hvid

H 65mm
B 560mm
D 15mm
0,40kg

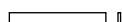

1105/GS/GH-SE

gavl plade for podie ved fritstående set-up af væg units og gulvstativ 1005/GS/O inkl. ben 1005/GH-11,5

mdf, vådlakeret
farve
hvid

H 182mm
B 560mm
D 15mm
0,80kg

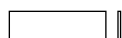

type nr / beskrivelse	materiale	dimensioner / vægt
-----------------------	-----------	--------------------

1105/GL-SE

gavl plade for podie ved fritstående set-up af væg units og gulvstativ 1005/GL-59,5.

mdf, vådlakeret
farve
hvid

H 65mm
B 610mm
D 15mm
0,40kg

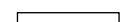

1105/GH-SE

gavl plade for podie ved fritstående set-up af væg units og gulvstativ 1005/GL-59,5 inkl. ben 1005/GH-11,5

mdf, vådlakeret
farve
hvid

H 182mm
B 610mm
D 15mm
0,80kg

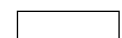

PODIER / fritstående

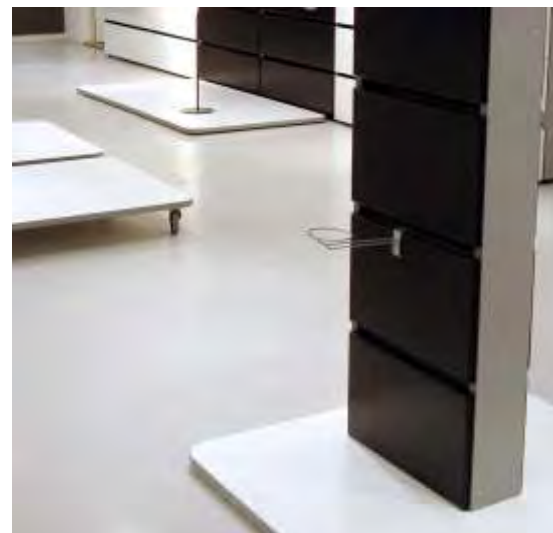

PODIER / podie, addition

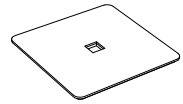

type nr / beskrivelse	materiale	dimensioner / vægt
PO/ADD - A top plade for additions podier m/hul f/kabler	mdf, vådlakeret farve hvid	H 25mm B 650mm D 650mm 7,30kg

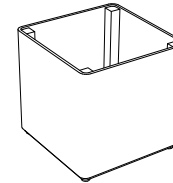

type nr / beskrivelse	materiale	dimensioner / vægt
PO/ADD - D kvadratisk korpus, høj	mdf, vådlakeret farve hvid	H 625mm B 650mm D 650mm 28,70kg
inkluderet 4x stillesko		

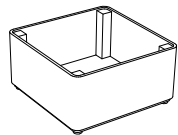

type nr / beskrivelse	materiale	dimensioner / vægt
PO/ADD - B kvadratisk korpus, lav	mdf, vådlakeret farve hvid	H 320mm B 650mm D 650mm 17,50kg
inkluderet 4x stillesko		

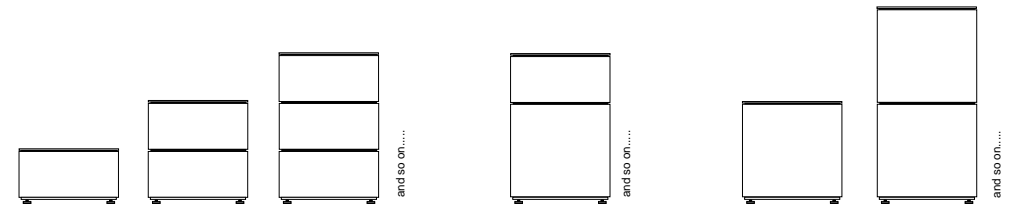

PODIER / podier - bord plader

type nr / beskrivelse	materiale	dimensioner / vægt
 1108/P-104 podie kvadratisk. Kan også bruges som bordplade ved montering af ben inkluderet 6x stillesko	mdf, melamin farve hvid / grå pvc kant	H 30mm B 1040mm D 1040mm 9,40kg

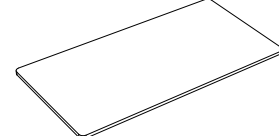
type nr / beskrivelse	materiale	dimensioner / vægt
 1108/P-208 podie rektangulært. Kan også bruges som bordplade ved montering af ben inkluderet 8x stillesko	mdf, melamin farve hvid / grå pvc kant	H 30mm B 2080mm D 1040mm 18,80kg

type nr / beskrivelse	materiale	dimensioner / vægt
 1108/P-155 podie rektangulært. Kan også bruges som bordplade ved montering af ben inkluderet 6x stillesko	mdf, melamin farve hvid / grå pvc kant	H 30mm B 1550mm D 650mm 8,90kg



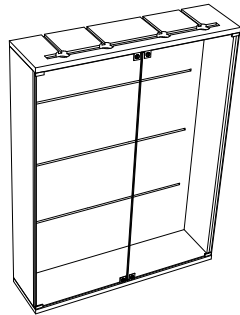

type nr / beskrivelse	materiale	dimensioner / vægt
1124/136 glas unit for væg unit B104cm inkluderet - 4x låse/nøgler - 4x hængsler - 6x træskruer for væg ophæng - 4x udskæringer for indbg. spots, eksl. spots Leveres usamlet.	mdf, vådlakeret klar, hærdet farve hvid	H 1358mm B 1030mm D 275mm 51,00kg
	Muligt tilvalg: LED spot 3,2W samt transformere	

fittings for glas unit

Valg af fittings for glas unit 1124/136:

Du kan vælge følgende fittings til brug i vores glas unit:
 - vores små metal hylder - se side 4, 6 og 8 i katalog nr 2
 - vores forskellige accessories kroge - se side 19 i katalog nr 2
 - glas hylder 1210-2N og 1210-4N - - se side 16 i katalog nr 2
 glas hylde placeres direkte i slidsen i bagpladen på glas unit og ind mellem vanger på væg unit.

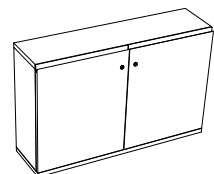

type nr / beskrivelse	materiale	dimensioner / vægt
1124B/65 base unit som fritstående eller monteret med glas unit 1124/136 inkluderet - 2x låse/nøgler - 4x hængsler - 2x hylder inkl. 8x holdere f/hylder - 4x stillesko Leveres usamlet.	mdf, vådlakeret farve hvid	H 650mm B 1030mm D 275mm 32,00kg

type nr / beskrivelse	materiale
Spot f. 1124/136 - 1124/F/184 - indbg. spot LED 12V/3,2W - transformer 12V/15W incl. netledning EUR	farve silver

SKABS UNITS / glas units - base units

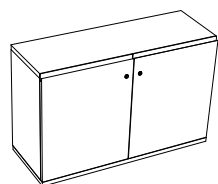

type nr / beskrivelse	materiale	dimensioner / vægt
1124BD/65 base unit som fritstående eller monteret med glas unit 1124/136	mdf, vådlakeret	H 650mm B 1030mm D 401mm
inkluderet - 2x låse/nøgler - 4x hængsler - 2x hylde inkl. 8x holdere f/hylde - 4x stillesko Leveres usamlet.	farve hvid	37,00kg

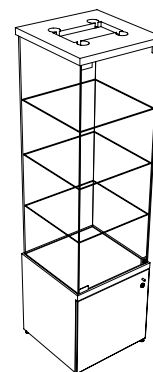

type nr / beskrivelse	materiale	dimensioner / vægt
1124/F/184 fritstående glas unit inkl. skabs unit	mdf, vådlakeret klar, hærdet	H 1820mm B 510mm D 510mm
inkluderet - 3x låse/nøgler - 1x greb - 4x hængsler - 3x glas hylde inkl. 12x holdere f/glas hylde - 4x stillesko - 4x cut-outs for indbg. spot, eksl. spots Leveres usamlet	farve hvid	30,80kg
Muligt tilvalg: LED spot 3,2W samt transformer.		

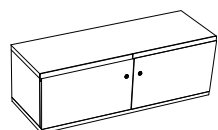

type nr / beskrivelse	materiale	dimensioner / vægt
1124BD/31 base unit som fritstående eller som podie	mdf, vådlakeret	H 310mm B 1030mm D 401mm
inkluderet - 2x låse/nøgler - 4x hængsler - 2x hylde inkl. 8x holdere f/hylde - 4x stillesko - 2x træskruer for ophæng på væg unit Leveres usamlet.	farve hvid	27,00kg

DISKE / top diske-base units



DISKE / top diske - base units

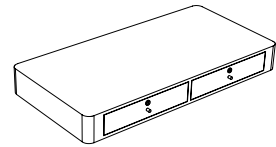

type nr / beskrivelse	materiale	dimensioner / vægt
1123-130 disk top med to skuffer kan monteres med 1 eller 2 base units, 1123/B eller 1123/BD	mdf, våd lakering	H 150mm B 1300mm D 650mm
inkluderet 2x lås m. nøgle 2x greb	farve hvid	26,00kg

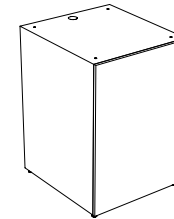

type nr / beskrivelse	materiale	dimensioner / vægt
1123/B skabsunit for montering med disk top 1123-130 eller 1123-65	mdf, våd lakering	H 780mm B 550mm D 600mm
inkluderet 2x flytbare hylder inkl. 8x holdere f/hylder 1x lås m. nøgle 1x greb 4x stillesko 4x bolt M8x30 4x skiver	farve hvid	29,50kg

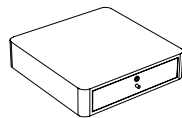

type nr / beskrivelse	materiale	dimensioner / vægt
1123-65 disk top med en skuffer kan monteres med 1 base unit, 1123/B eller 1123/BD	mdf, våd lakering	H 150mm B 650mm D 650mm
inkluderet 1x lås m. nøgle 1x greb	farve hvid	15,90kg

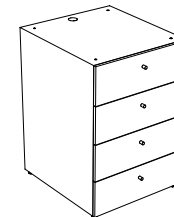

type nr / beskrivelse	materiale	dimensioner / vægt
1123/BD skuffeunit for montering med disk top 1123-130 eller 1123-65	mdf, våd lakering	H 780mm B 550mm D 600mm
inkluderet 4x greb 4x stillesko 4x bolt M8x30 4x skiver	farve hvid	35,00kg

DISKE / glas til top diske

type nr / beskrivelse	materiale	dimensioner / vægt
1123-130/GL glasplade med rundet hjørner for disk top 1123-130	hærdet glas	H 10mm B 1300mm D 650mm
inkluderet 6x pvc dup	farve transparent	16,00kg



type nr / beskrivelse	materiale	dimensioner / vægt
1123-65/GL glasplade med rundet hjørner for disk top 1123-65.	hærdet glas	H 10mm B 650mm D 650mm
inkluderet 4x pvc dup	farve transparent	8,70kg



type nr / beskrivelse	materiale	dimensioner / vægt
1123-130/GLH glasplade med rundet hjørner samt hul f. kabelføring for disk top 1123-130. Kan højre- /venstre stilles	hærdet glas	H 10mm B 1300mm D 650mm
inkluderet 6x pvc dup	farve transparent	16,00kg



type nr / beskrivelse	materiale	dimensioner / vægt
1123-65/GLH glasplade med rundet hjørner samt hul f. kabelføring for disk top 1123-65.	hærdet glas	H 10mm B 650mm D 650mm
inkluderet 4x pvc dup	farve transparent	8,70kg

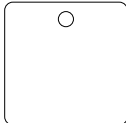

DISKE / top diske - base units

disk top 1123-65

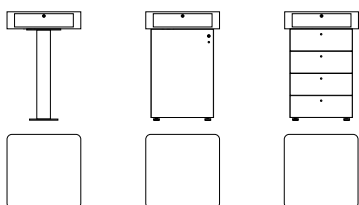

.....sammensæt din disk efter behov

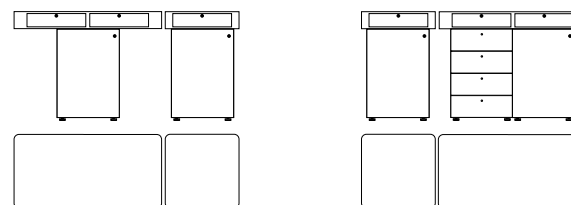

disk top 1123-130

